

1T8531EL | OZ Stand Alone Recessed Recessed LED floodlights

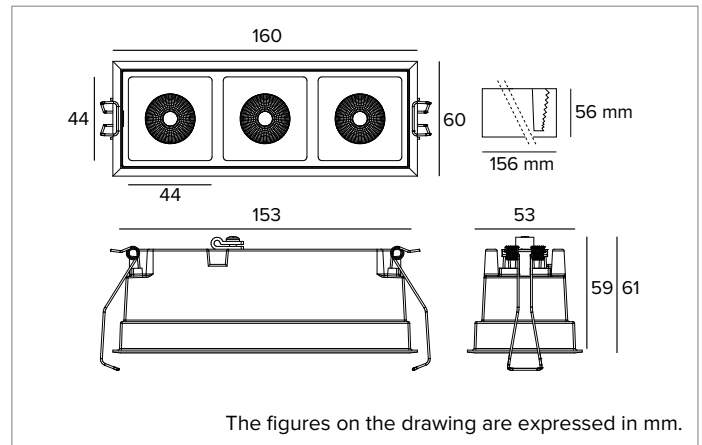

	3000K	H(m)	D1(m)	D2(m)	E _{max} (lx)		
	Ra90	58°	25°				
Fixture Power	11W	1	1.11	0.44	1964		
Source Flux	1395lm	2	2.21	0.88	491		
Fixture Flux	1004lm	3	3.32	1.32	218		
Efficacy	90lm/W	4	4.43	1.76	123		
TS1254	I _{max} =1408cd/klm	I _{max}	1964cd	5	5.54	2.19	79



SOURCE

High efficiency Chip on Board LED Ra90.

Energy efficiency class: F

Nominal power: 9,9W

Nominal flux: 1395lm

Colour rendering index: 90

Rf: 92

Rg: 101

CCT nominal: 3000K

SDCM: 2

Lifetime (L80/B10): >50000h tq +25°C

ILLUMINOTECHNICAL CHARACTERISTICS

ELL optic. Anodised aluminium reflector, a holographic filter and a black polycarbonate frame. The fixture is suitable for installation in workplaces UGR<13/22 (EN12464-1).

Optic: REFLECTOR

Beam angles: ELL

Optical efficiency: 72%

Fixture flux: 1004lm

Luminous efficacy: 90lm/W

Photobiological safety: Compliant with RG1 low risk group

MECHANICAL CHARACTERISTICS

Black painted die-cast aluminium body. 3X Large version.

Colour and finish: Deep black

Dimensions: Ax B=160x60mm

Weight: 0.5Kg

Version: 3X

Degree of protection: IP20

ELECTRICAL CHARACTERISTICS

Complete with an electronic ON-OFF driver. Luminaire compliant with EN 60598-2-22 for power supply from a centralised emergency system CPSS (Central Power Supply System), not incorporated in the luminaire - high risk areas excluded. The default power and flux are 100% in AC and 100% in DC.

Fixture Power: 11W

Power supply: 220-240Vac 50/60Hz

Insulation Class: CLASS 2

Type of driver / Control: ON-OFF

Driver included: YES

Class F: YES

SAFE FLICKER: PstLM=<1 and SVM=<0.4 (IEC TR 61547-1 and IEC TR 63158), to ensure a more comfortable and safe light

Ambient temperature: 0°C / +25°C

INSTALLATION

Quick fastening system with springs for installation in false ceilings from 0 to 30mm.

NOTES

110-277Vac version available on request.

WARRANTY

5 years.

WARNING

Luminaire designed for disposal/recycling at end-of-life. Replaceable (LED only) light source by a professional. Replaceable control gear by a professional.

Due to the technological evolution of the electronic components, the data provided may be updated, and as such, confirmation must be requested during the order process.

Luminous flux and power supply have +/-10% tolerances with respect to the indicated value. tq +25°C (CIE 121).

We reserve the right to make technical changes.

Targetti Sankey S.r.l.
Via Pratese, 164
50145 Firenze - Italy
Tel: +39 055 37911
targetti.com
targetti@targetti.com

CCIAA Firenze
Share Capital:
€ 500.000,00
VAT N. (IT):
01537660480
R.E.A: FI-275656

TARGETTI

1T8531EL | OZ Stand Alone Recessed Recessed LED floodlights

Accessories

Emergency Kit



Code

A059

Emergency kit composed of an inverter a LiFePO4 battery and a LED Green indicator. Allows permanent EP emergency use of the fixture it is connected to.

The 1h or 3h autonomy can be selected by configuring the fixture.

The batteries take 12h to completely recharge.

LED Green indicator wired to the inverter through single-core cables L= 800mm.

Emergency kit for fixtures that comply with EN 60598-2-22 standard, high risk areas excluded.

Battery size 160x54x30 mm.

Inverter size 165x40x25 mm.

Due to the technological evolution of the electronic components, the data provided may be updated, and as such, confirmation must be requested during the order process.

Luminous flux and power supply have +/-10% tolerances with respect to the indicated value. tq +25°C (CIE 121).

We reserve the right to make technical changes.

Targetti Sankey S.r.l.
Via Pratese, 164
50145 Firenze - Italy
Tel: +39 055 37911
targetti.com
targetti@targetti.com

CCIAA Firenze
Share Capital:
€ 500.000,00
VAT N. (IT):
01537660480
R.E.A: FI-275656

TARGETTI